

TOP VIEW

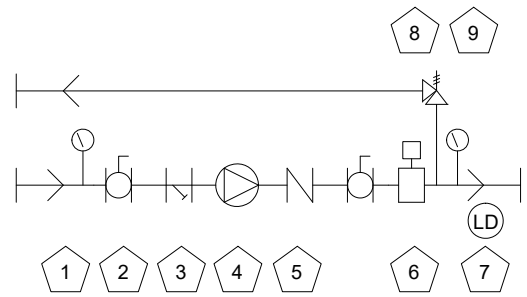

SIDE VIEW

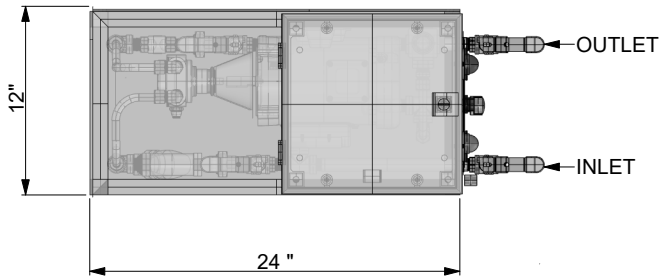
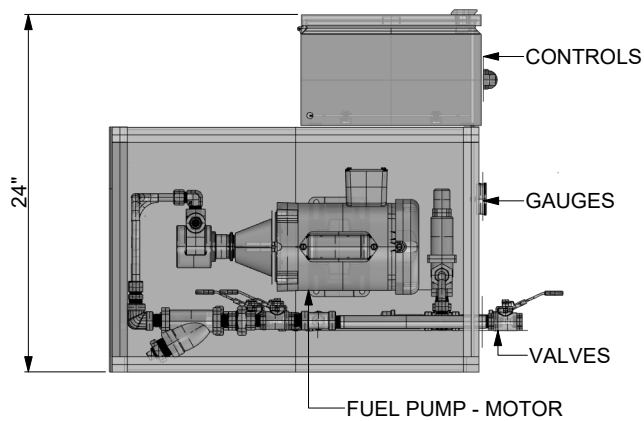

DETAILS LEGEND

MARK	QTY	DESCRIPTION
1	1	SUCTION GAUGE
2	2	BALL VALVE
3	1	STRAINER
4	1	FUEL PUMP AND MOTOR
5	1	CHECK VALVE
6	1	FLOW SENSOR
7	1	LEAK SENSOR
8	1	BACK PRESSURE VALVE
9	1	PRESSURE GAUGE
10	1	ENCLOSURE
11	1	CONTROL PANEL

FRONT VIEW

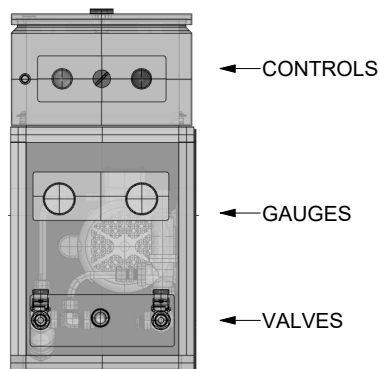

COMMENTS:

1. INLET AND OUTLET ARE 1/2 IN FOR 5GPM AND LESS, 3/4 IN FOR 10 GPM, AND 1 IN FOR OVER 10 GPM