

DM330 Series

Magnetostrictive Liquid Level Sensor



Proven
Magnetostrictive
Sensing
Performance
with Field
Programmable
Span.

Easy Installation

- No calibration needed
- Program zero & span in the field
- Set upper and lower limits on bench prior to installation.

High Accuracy

- 0.1% accuracy full scale over 4-20mA span.

Minimal Maintenance

- Unique diagnostic output provides float position beyond set span, beyond active range, as well as loss of float.

Patented Low Clearance Design

- Electronics all within 5/8" diameter sensor allows wider mounting options at less cost.

Patented Flexible Probe

- PVDF version provides cost effective, high accuracy inventory monitoring up to 40 feet with flexibility and reduced weight for easier installation.

Intrinsically Safe

- FM, ATEX, CSA, CE, 3A Approved

Magnetostrictive Level Measurement System takes field proven sensing technology and incorporates intrinsic safety with a field programmable zero and span. Packaging is our patented low clearance design, making the DM330 ideal for level monitoring in a variety of liquids and tank designs.

Two Variations - Sensors are available in rigid 316SS or flexible PVDF designs. The stainless steel version has a choice of a mini-connector or an optional housing which includes terminal connectors with zero and span adjustments. All offer totally welded construction.

The flexible (PVDF) version offers with a variety of mounting options and provides cost effective, high accuracy inventory monitoring in tanks up to 40 feet.

All of the sensor's electronics are integrated within the 5/8 " diameter sensing tube. This breakthrough in package design eliminates the electronics enclosure at the top of the sensor, which reduces cost and offers greater options for insertion and mounting.

The DM330 is a two wire loop powered intrinsically safe sensor with a configurable 4 -20 mA span.

A variety of floats and mounting accessories are available to fit virtually any application. Included is a sanitary stainless steel version. Contact the factory to match your needs today.



Continuous Level Measurement

DM330 Series

Specifications

- Technology:**
 Magnetostrictive
- Calibration:**
 None
- Operating Voltage:**
 13.5 to 30Vdc
- Loop Impedance (R):**
 1000 ohms 24Volts
- Output:**
 4 to 20mA
- Temperature Range:**
 -20°C to 100°C (-4°F to 212°F)
 Not Approved for Hazardous Locations above 70°C (158°F)
- Null Zone:**
 -20°C to 70°C (-4°F to 158°F)
 Max.
- Pressure Rating:**
 Stainless Steel:
 1000psi (69 bar)
 float dependent
 PVDF (flexible):
 150 psi (10 bar)
- Resolution:**
 0.025% full scale or
 0.014" (0.35mm)
 (whichever is greater)
- Repeatability:**
 0.014" + 0.05% of span
 typical, 0.014" + 0.4%
 of span max
- Accuracy:**
 0.1% or 0.050" (1.27mm)
 (whichever is greater)
- Enclosure:**
 Stainless Steel Standard
 Epoxy painted aluminum
 housing (option)
 Probe Material: 316SS
 Probe Rating: IP68
- Probe Length:**
 Stainless Steel: 20" - 192"
 (508 mm - 7315 mm)
Consult factory for lengths to 288"
 PVDF (flexible): 20" - 480"
 (508 mm - 12192 mm)
- Null Zone (Top):**
 Stainless Steel:
 8" (203 mm)
 PVDF (flexible):
 12" (305 mm)
- Deadband (Bottom):**
 Stainless Steel: 2" (51 mm)
 PVDF (flexible): 6 to 14"
 (152 mm to 356 mm)
- Approvals:**
 Approved Intrinsically Safe for
 hazardous locations by the
 following agencies



Class I Div 1



Class I Div 1



II 1 G, EEx ia 11B T4
T 70°C



0344



74-02

* Specifications may change without notice

Diagnostic Locates Float Position

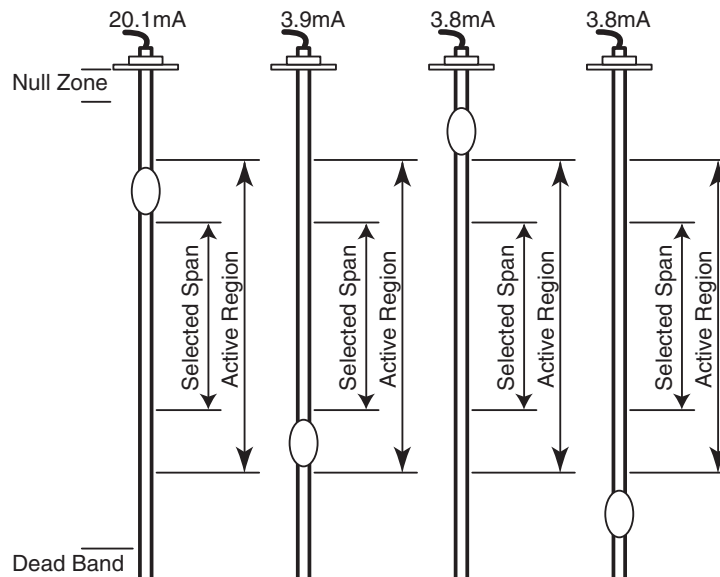

Continuous Level Measurement

DM330 Series

Dimensions inches, (mm)

M STYLE CONNECTOR

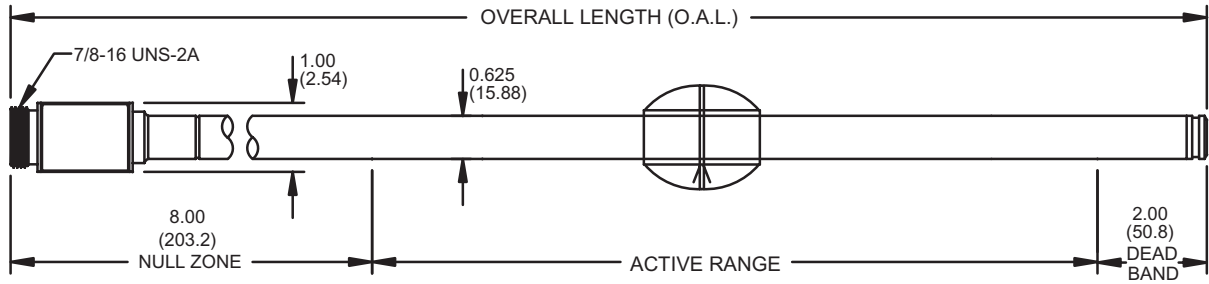

V STYLE CONNECTOR [PVDF VERSION]

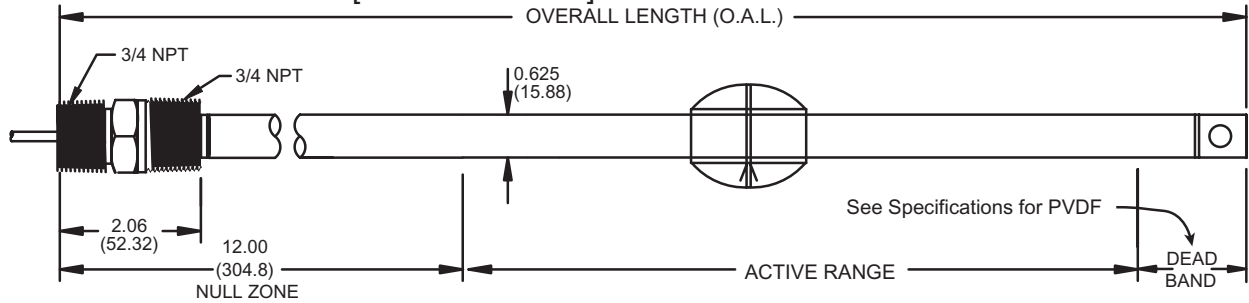

Wiring

"H" Housing Option

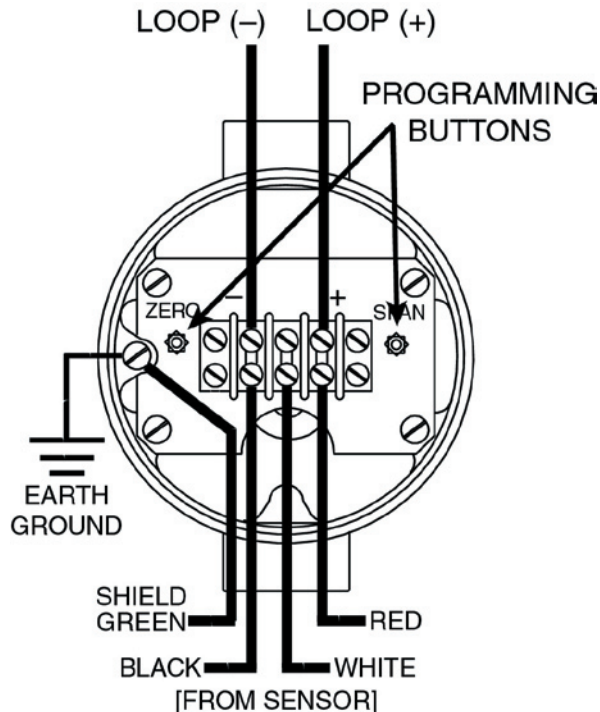

"M" Connector

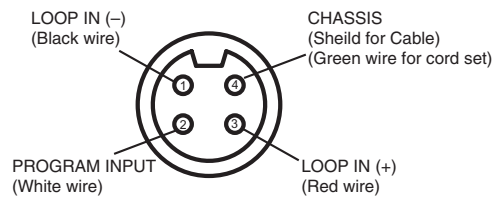

WIRING COLORS		
SIGNAL	US	EU
IN (+)	RED	BROWN
IN (-)	BLACK	BLACK
PROGRAM	WHITE	BLUE
CHASSIS	GREEN	WHITE

Continuous Level Measurement

DM330 Series

Model Numbering

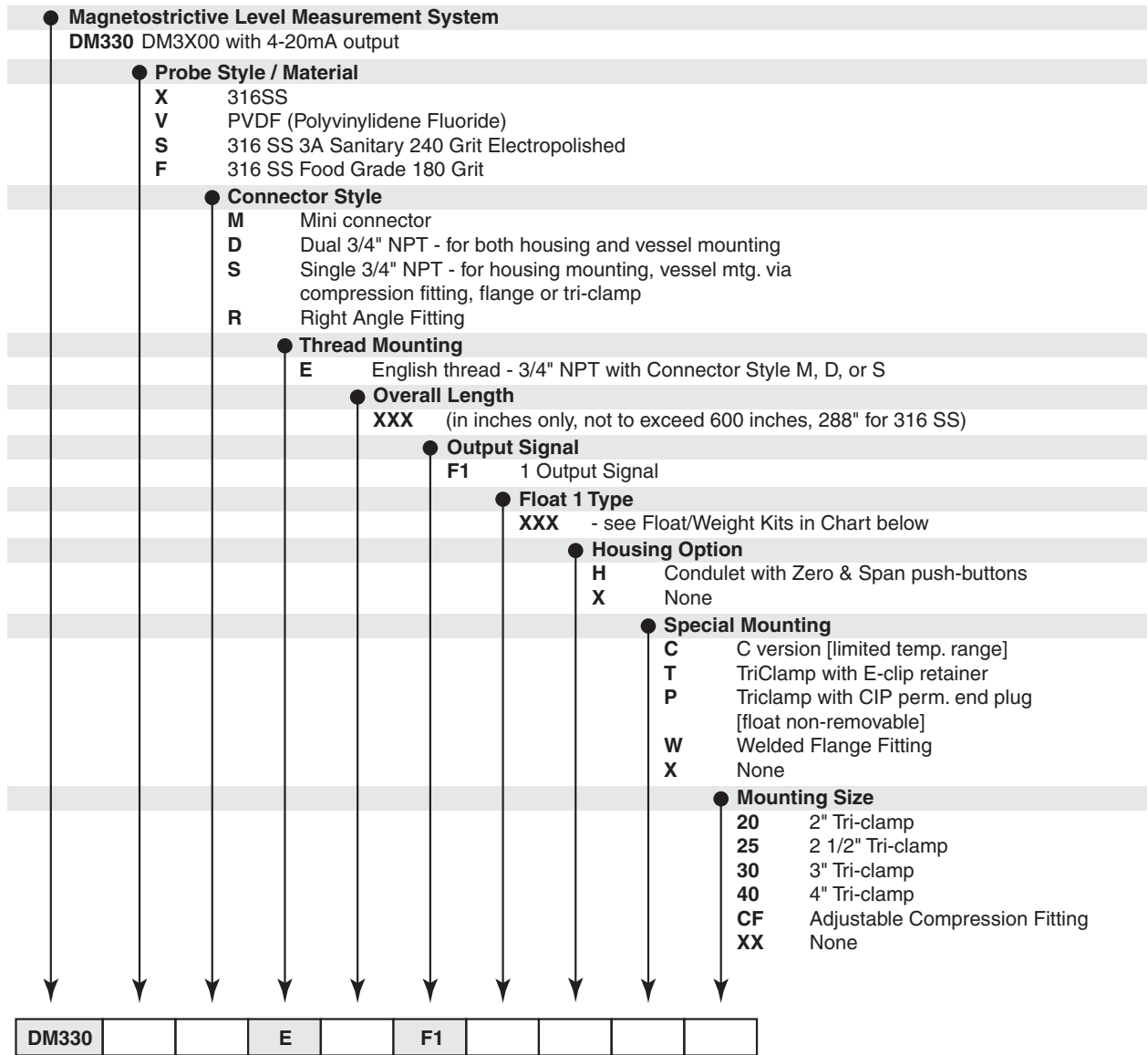

Float Kits

Float Type selection includes Float, spacer and retaining clip

	Material	Shape	Diameter	Hight	S.G.	Max. Press.
PS0	316SS	Oval	1.83"	2.94"	0.61	350psi
PUX*	Ureth	Cylind	3.85"	2.75"	0.52	50psi
PNX*	Nitrophyl	Round	2.02"	1.38"	0.4	300psi
PEX*	316SS	Oval	2.05"	2.7"	0.54	350psi
XXX	None					

YYY - Special Float / Float Kit ordered as a separate line item

X* = Weight Kit

Weight Kits

	Material	Shape	Dia.	Hight
0	316SS	No weight kit on	Stainless Steel probes (X, S, F)	
1	316SS	Round	2"	5"
2	316SS	Round	2"	7"
3	316SS	Round	2"	11"
4	316SS	Round	2"	13"

AMETEK® DREXELBROOK®

205 Keith Valley Road, Horsham, PA 19044 U.S.A.

Tel: 215-674-1234 Fax: 215 674-2731

Email: drexelbrook.info@ametek.com

Web: www.drexelbrook.com