

earth safe

Fuel Systems for Critical Facilities

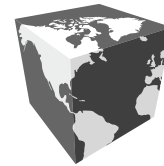

EMERGENCY POWER FUEL SYSTEMS

VERSION: ENGLISH—GLOBAL

CentraPlex Model C915

Integrated System Control Module

BACnet, Modbus, Metasys N2, or
LON Communications



Application

Diesel Generator Power Systems

The CentraPlex provides an integrated control and monitoring for mission critical fuel systems applications. The unit is flexible to be configured for systems ranging from 1 to 10 generator day tanks. The CentraPlex combines the functions of:

- (a) Duplex Pump Control
- (b) Day Tank Level Control
- (c) Tank Level and Leak Detection
- (d) Fuel Filtration Monitoring / Control

The CentraPlex is also compatible with Earthsafe PowerPlex Control Modules. This allows the integration of other system functions such as heater controls and tank fill systems.

The CentraPlex provides a graphic interface to display all system information, including alarms, for facility personnel. Equipment detail screens are accessed from the main menu screen to provide maintenance information.

The Modbus / BACNet output from the CentraPlex allows for integration into the facility BMS.

Quick Spec

Provide the Earthsafe CentraPlex Integrated System Control Module. The system shall integrate the control and monitoring functions for all day tanks, pump sets, tank level gauging, leak detection, and filtration. The unit shall be based on an AB Industrial PLC and shall have ON-OFF-AUTO selector switches for individual system components. The system shall be provided with all required day tank level sensors, leak sensors, main tank level transmitters, pump flow switches, filter DP switches, and filter water switches. The Control Module shall have a graphic screen for system status information and a Modbus / BACNet output for BMS integration.

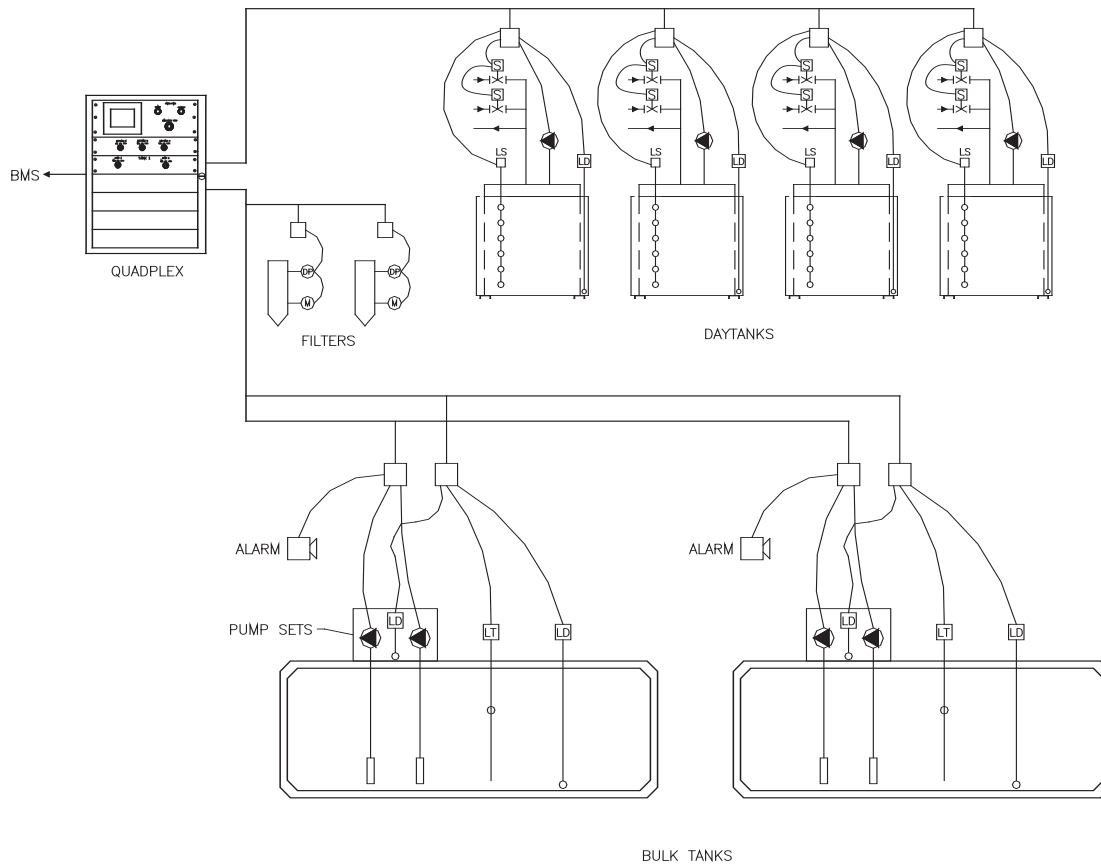

Control Specification		
Power	120-240 VAC / 15 Amp	
Enclosure	NEMA 4 610mm x 915mm x 205mm Color RAL 7035 Light Gray	
Environmental	0 to 55 C	
Monitor	150mm Color Touchscreen	
Data Output	BACnet, Modbus, Metasys N2, or LON	
Approvals	UL / CE	
Input (TYPE AND NUMBER)	Level Sensors (5 Point)	4
	Leak Sensors	8
	Level XMTR	2
	Flow Switches	4
	Filter DP Switch	2
	Filter Water Switch	2
	Emergency Stop	2
Outputs (TYPE AND NUMBER)	Day Tank Solenoid Valves	8
Surge Suppression	Pump Motor Starts	8
Rated 5 Amp Max	High Level Alarm	1
	Programmable Relays	4
Alarm Conditions	Day Tank High, Low, Critical Low Levels Main Tank High and Low Levels Leak Detection Pump Flow Failure or Overload Filter High DP or Water	
Options	50 Hz Power Ethernet Output Intrinsic Safety Sensors	Dual Power Source Enclosure Heater Enclosure Fan
Accessories	Remote Display Day Tank Level Sensors Tank Level Transmitters Tank Leak Sensors	Pump Flow Sensors Filter DP Sensors Filter Water Sensors

PowerPlex Modular Fuel System

Networked Modular Fuel System for Critical Facilities

Touch Screen User Interface: C700 NIM and C915 CentraPlex Modules

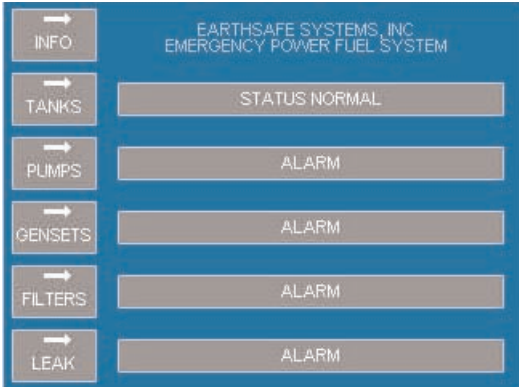

Main

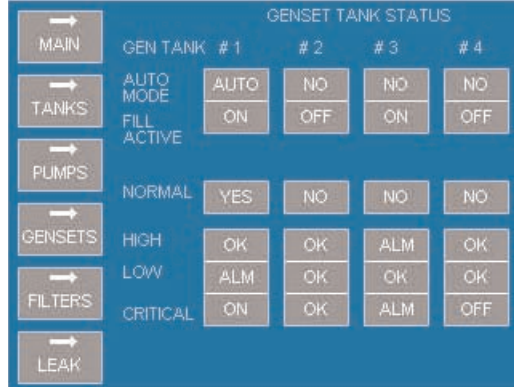

Gensets

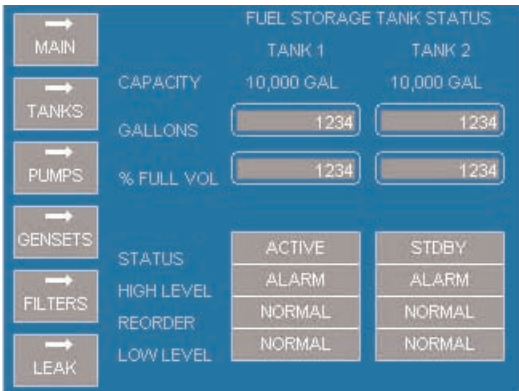

Tank

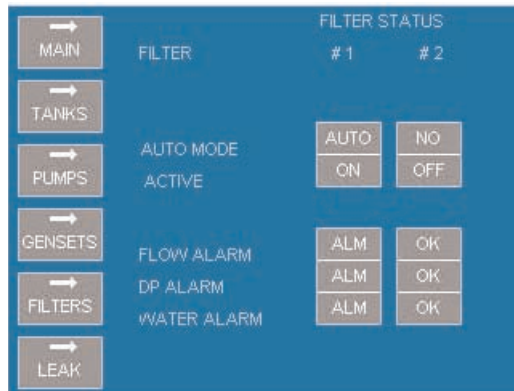

Filters

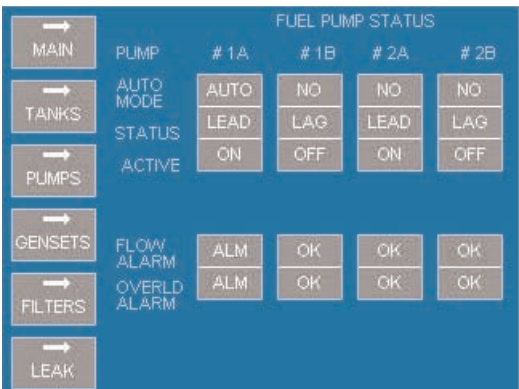

Pumps

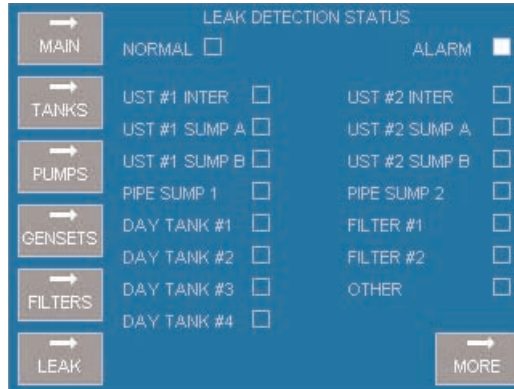

Leak

Earthsafe Systems, Inc.
1312 Marquette Drive, Unit J
Romeoville, IL 60446

T: (630) 794-5100
F: (630) 794-5106

info@earthsafe.com
www.earthsafe.com